

Phase leg

Series & parallel diodes

MOSFET Power Module

$V_{DSS} = 1000V$

$R_{DSon} = 130m\Omega$ typ @ $T_j = 25^\circ C$

$I_D = 65A$ @ $T_c = 25^\circ C$

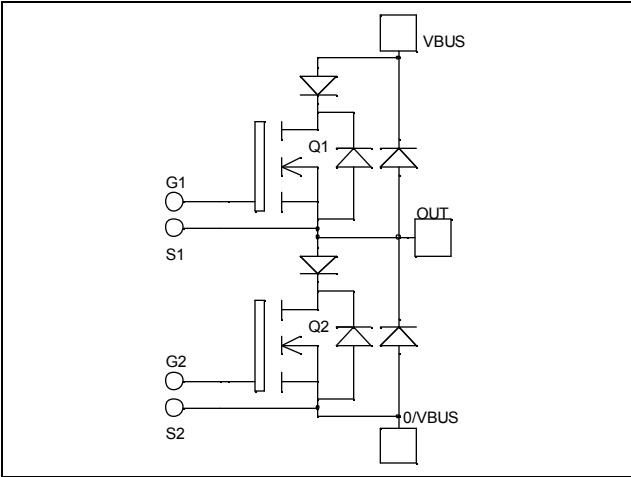

Application

- Motor control
- Switched Mode Power Supplies
- Uninterruptible Power Supplies

Features

- Power MOS 7[®] MOSFETs
 - Low R_{DSon}
 - Low input and Miller capacitance
 - Low gate charge
 - Fast intrinsic reverse diode
 - Avalanche energy rated
 - Very rugged
- Kelvin source for easy drive
- Very low stray inductance
 - Symmetrical design
 - M5 power connectors
- High level of integration

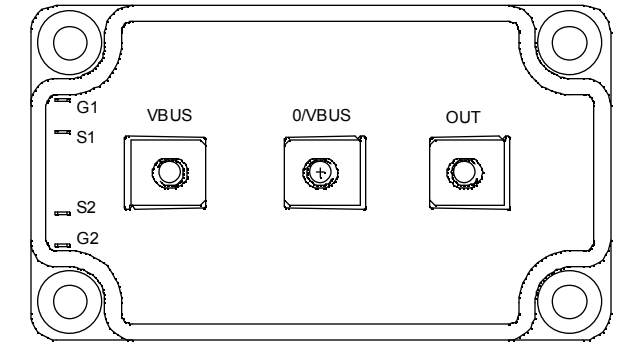

Benefits

- Outstanding performance at high frequency operation
- Direct mounting to heatsink (isolated package)
- Low junction to case thermal resistance
- Low profile
- RoHS Compliant

Absolute maximum ratings

Symbol	Parameter	Max ratings	Unit
V_{DSS}	Drain - Source Breakdown Voltage	1000	V
I_D	Continuous Drain Current	$T_c = 25^\circ C$	65
		$T_c = 80^\circ C$	49
I_{DM}	Pulsed Drain current	240	A
V_{GS}	Gate - Source Voltage	± 30	V
R_{DSon}	Drain - Source ON Resistance	156	$m\Omega$
P_D	Maximum Power Dissipation	$T_c = 25^\circ C$	1250
I_{AR}	Avalanche current (repetitive and non repetitive)	24	A
E_{AR}	Repetitive Avalanche Energy	30	mJ
E_{AS}	Single Pulse Avalanche Energy	1300	

 **CAUTION:** These Devices are sensitive to Electrostatic Discharge. Proper Handling Procedures Should Be Followed. See application note APT0502 on www.microsemi.com

All ratings @ $T_j = 25^\circ\text{C}$ unless otherwise specified

Electrical Characteristics

Symbol	Characteristic	Test Conditions	Min	Typ	Max	Unit
I_{DSS}	Zero Gate Voltage Drain Current	$V_{GS} = 0\text{V}, V_{DS} = 1000\text{V}$			600	μA
		$V_{GS} = 0\text{V}, V_{DS} = 800\text{V}$			2	mA
$R_{DS(on)}$	Drain – Source on Resistance	$V_{GS} = 10\text{V}, I_D = 32.5\text{A}$		130	156	$\text{m}\Omega$
$V_{GS(th)}$	Gate Threshold Voltage	$V_{GS} = V_{DS}, I_D = 6\text{mA}$	3		5	V
I_{GSS}	Gate – Source Leakage Current	$V_{GS} = \pm 30\text{V}, V_{DS} = 0\text{V}$			± 450	nA

Dynamic Characteristics

Symbol	Characteristic	Test Conditions	Min	Typ	Max	Unit
C_{iss}	Input Capacitance	$V_{GS} = 0\text{V}$		15.2		nF
C_{oss}	Output Capacitance	$V_{DS} = 25\text{V}$		2.6		
C_{rss}	Reverse Transfer Capacitance	$f = 1\text{MHz}$		0.42		
Q_g	Total gate Charge	$V_{GS} = 10\text{V}$		562		nC
Q_{gs}	Gate – Source Charge	$V_{Bus} = 500\text{V}$		75		
Q_{gd}	Gate – Drain Charge	$I_D = 65\text{A}$		363		
$T_{d(on)}$	Turn-on Delay Time	Inductive switching @ 125°C		9		ns
T_r	Rise Time	$V_{GS} = 15\text{V}$		9		
$T_{d(off)}$	Turn-off Delay Time	$V_{Bus} = 667\text{V}$		50		
T_f	Fall Time	$I_D = 65\text{A}$ $R_G = 0.5\Omega$		24		
E_{on}	Turn-on Switching Energy	Inductive switching @ 25°C		2.13		mJ
E_{off}	Turn-off Switching Energy	$V_{GS} = 15\text{V}, V_{Bus} = 667\text{V}$ $I_D = 65\text{A}, R_G = 0.5\Omega$		0.46		
E_{on}	Turn-on Switching Energy	Inductive switching @ 125°C		4.4		mJ
E_{off}	Turn-off Switching Energy	$V_{GS} = 15\text{V}, V_{Bus} = 667\text{V}$ $I_D = 65\text{A}, R_G = 0.5\Omega$		0.57		

Series diode ratings and characteristics

Symbol	Characteristic	Test Conditions	Min	Typ	Max	Unit
V_{RRM}	Maximum Repetitive Reverse Voltage		200			V
I_{RM}	Maximum Reverse Leakage Current	$V_R = 200\text{V}$	$T_j = 25^\circ\text{C}$		350	μA
			$T_j = 125^\circ\text{C}$		600	
I_F	DC Forward Current			60		A
V_F	Diode Forward Voltage	$I_F = 60\text{A}$		1.1	1.15	V
		$I_F = 120\text{A}$		1.4		
		$I_F = 60\text{A}$	$T_j = 125^\circ\text{C}$	0.9		
t_{rr}	Reverse Recovery Time	$I_F = 60\text{A}$ $V_R = 133\text{V}$	$T_j = 25^\circ\text{C}$	24		ns
			$T_j = 125^\circ\text{C}$	48		
Q_{rr}	Reverse Recovery Charge	$di/dt = 400\text{A}/\mu\text{s}$	$T_j = 25^\circ\text{C}$	66		nC
			$T_j = 125^\circ\text{C}$	300		

Parallel diode ratings and characteristics

Symbol	Characteristic	Test Conditions		Min	Typ	Max	Unit
V_{RRM}	Maximum Repetitive Reverse Voltage			1000			V
I_{RM}	Maximum Reverse Leakage Current	$V_R=1000V$	$T_j = 25^\circ C$			350	μA
			$T_j = 125^\circ C$			600	
I_F	DC Forward Current				120		A
V_F	Diode Forward Voltage	$I_F = 120A$			1.9	2.5	V
		$I_F = 240A$			2.2		
		$I_F = 120A$	$T_j = 125^\circ C$		1.7		
t_{rr}	Reverse Recovery Time	$I_F = 120A$ $V_R = 667V$	$T_j = 25^\circ C$		280		ns
			$T_j = 125^\circ C$		350		
Q_{rr}	Reverse Recovery Charge	$di/dt = 400A/\mu s$	$T_j = 25^\circ C$		1520		nC
			$T_j = 125^\circ C$		7200		

Thermal and package characteristics

Symbol	Characteristic			Min	Typ	Max	Unit
R_{thJC}	Junction to Case Thermal Resistance	Transistor				0.10	$^\circ C/W$
		Diode series				0.65	
		Diode parallel				0.46	
V_{ISOL}	RMS Isolation Voltage, any terminal to case $t=1$ min, $I_{isol}<1mA$, 50/60Hz			2500			V
T_J	Operating junction temperature range			-40		150	$^\circ C$
T_{STG}	Storage Temperature Range			-40		125	
T_C	Operating Case Temperature			-40		100	
Torque	Mounting torque	To heatsink	M6	3		5	N.m
		For terminals	M5	2		3.5	
Wt	Package Weight					280	g

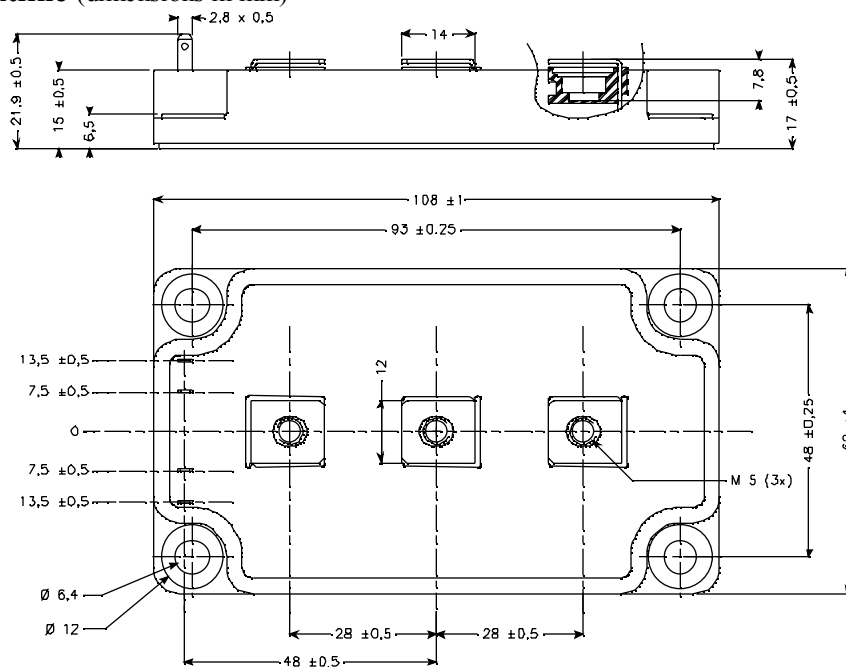
SP6 Package outline (dimensions in mm)

See application note APT0601 - Mounting Instructions for SP6 Power Modules on www.microsemi.com

Typical Performance Curve

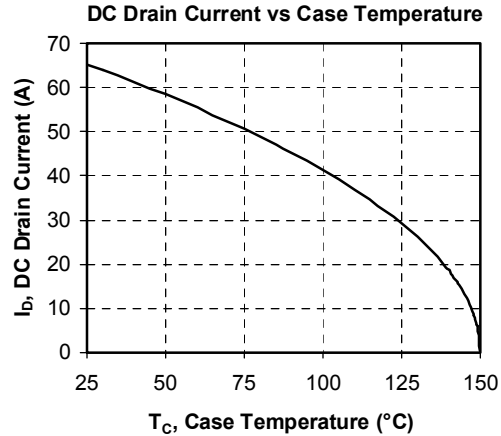
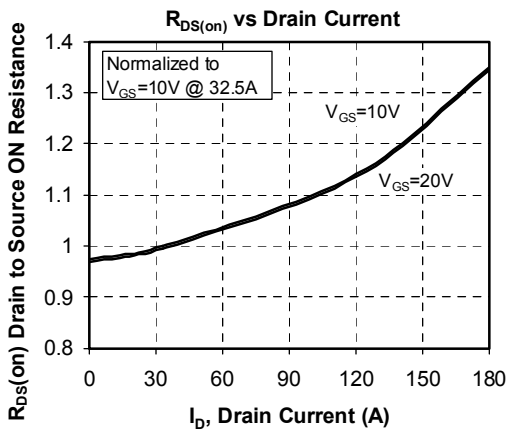
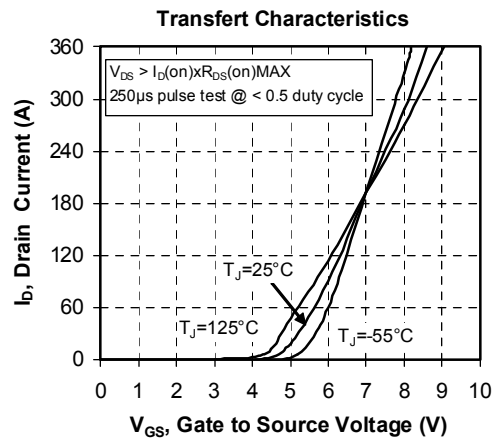
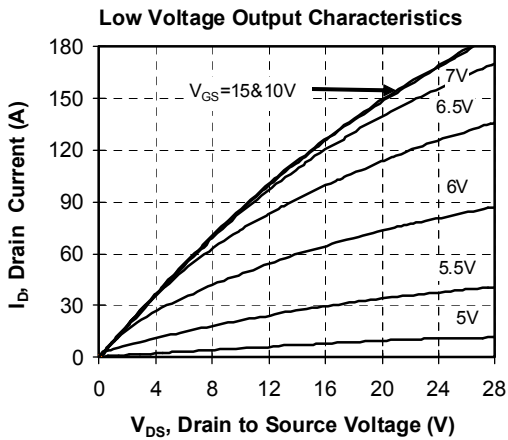
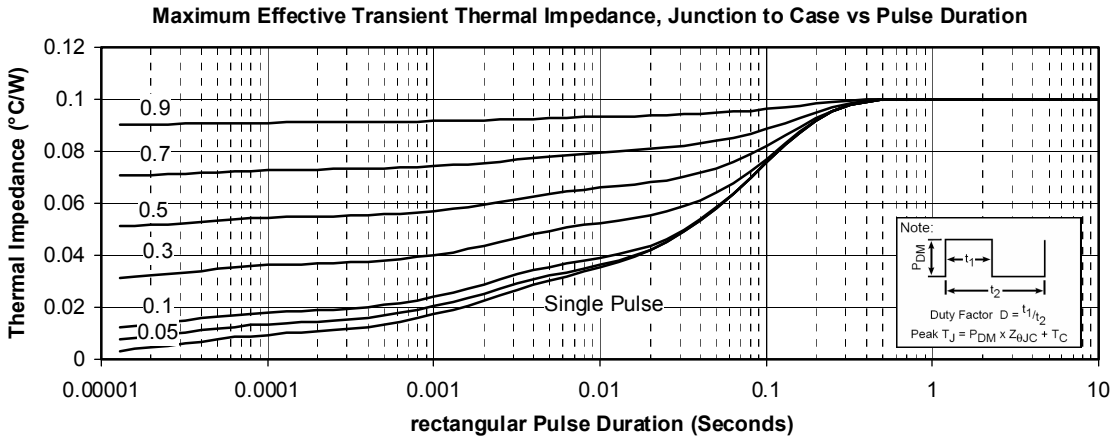

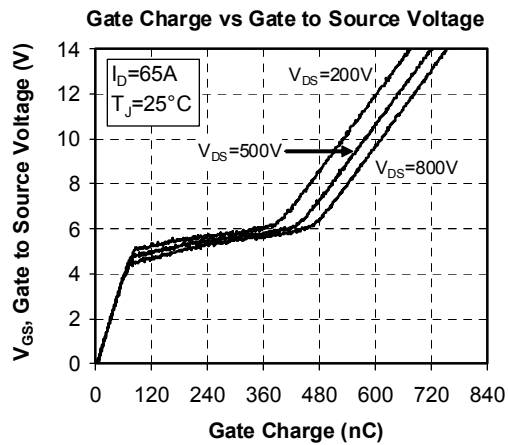
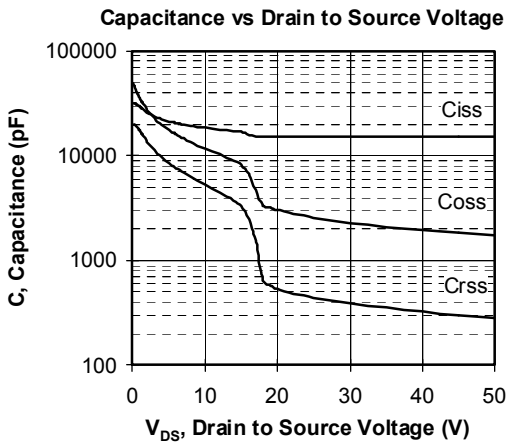
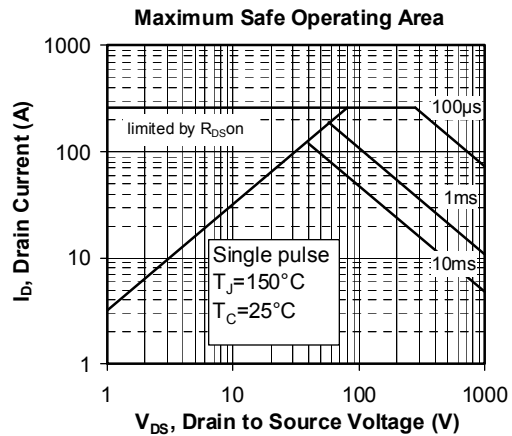
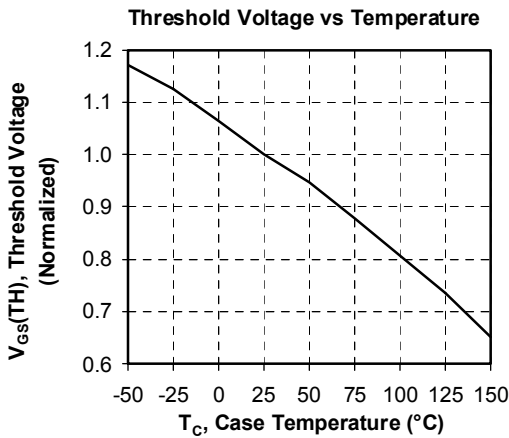
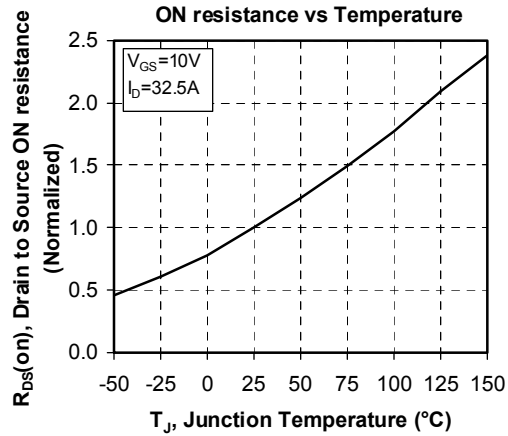
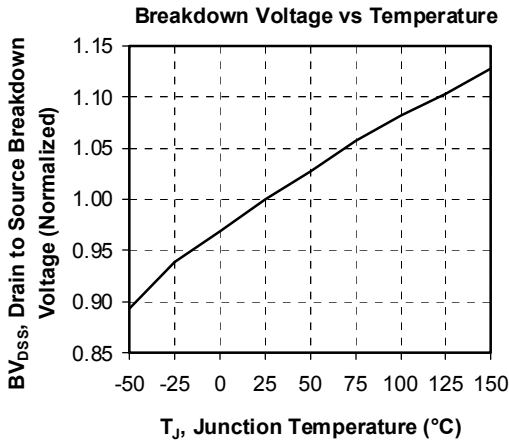

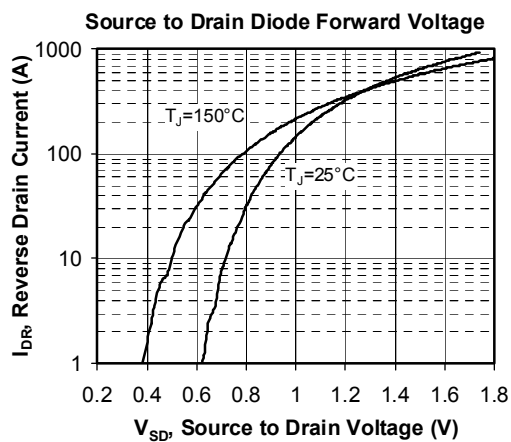
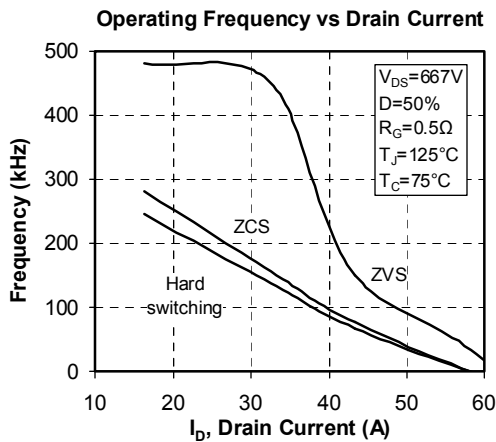
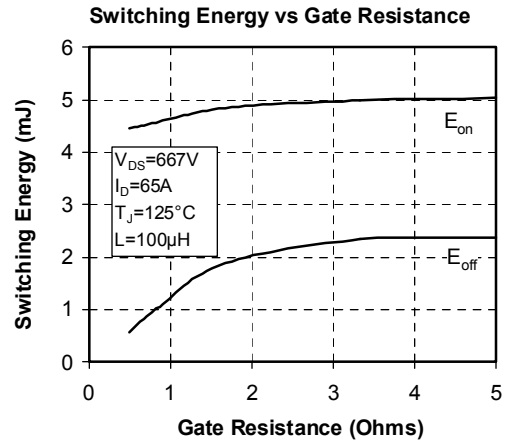
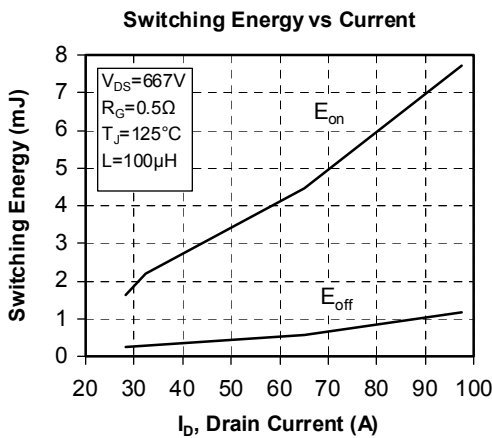
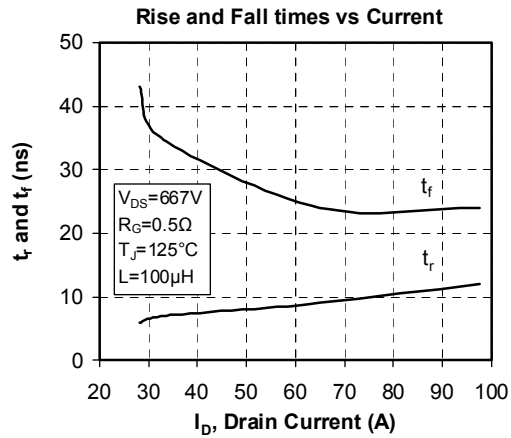
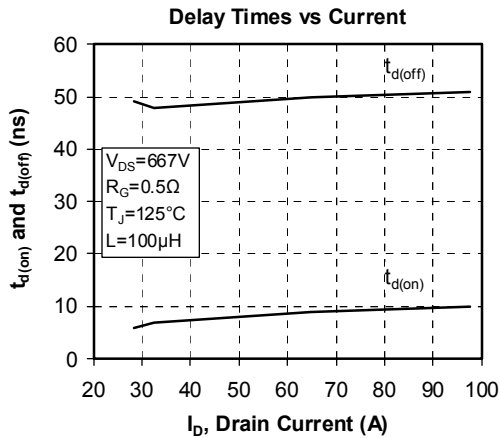

Microsemi reserves the right to change, without notice, the specifications and information contained herein

Microsemi's products are covered by one or more of U.S. patents 4,895,810 5,045,903 5,089,434 5,182,234 5,019,522 5,262,336 6,503,786 5,256,583 4,748,103 5,283,202 5,231,474 5,434,095 5,528,058 and foreign patents. U.S. and Foreign patents pending. All Rights Reserved.